

FastTest[®]

Your Productivity Connection

Leak Test Connector Selection Guide



FastTest
Your Productivity Connection

Introduction to FasTest

Leak Testing Today ...

Since 1985, **FasTest** advanced engineering creates connecting solutions that are easier, safer and more reliable while dramatically lowering your operating costs. With **FasTest**, you can expect increased operational throughput and a fast return on your investment.

Tens of thousands of satisfied customers have made the switch from their inadequate, unproductive leak test connectors to our engineered testing and filling solutions.

FasTest products are used by every major automotive manufacturer, top appliance companies, medical device manufacturers, aerospace, power generation, plus hundreds of other industries throughout the world.

Our complete selection of engineers products combined with extensive experience and expertise allows us to help you specify the right connector for your application. Small differences can diminish the suitability of a connector for your application. At **FasTest** we can modify standard products to fit your specific needs or engineer a total custom test system.

Helpful Hint ...

Cumbersome leak testing methods using jury-rigged adapters, fittings and test jigs is time-consuming, unreliable and may be unsafe to your workers.

FasTest connecting tools are available in many configurations - each precision engineered to perform specific pressure and vacuum test and built to fit your testing and process requirements.

FasTest offers extensive expertise to help you arrive at the optimum solution for your application and workflow. With over 50 patents and as the acknowledged expert in the field, chances are we've solved an application like yours, no matter how challenging.

Do as thousands of others have done. Make the switch from older inadequate or homemade jury-rigged adapters to **FasTest** engineered testing and filling solutions.

Seal Materials ...

Selecting the right seal material is critical to the reliability of the connector and the amount of maintenance required. **FasTest** manufactured seals exhibit superior wear resistance and maintain its sealing properties.

FasTest offers neoprene, urethane, Viton, EPDM, Buna-N, and FDA white neoprene. Our seals are manufactured via **FasTest** proprietary process which is why our seals are more durable, longer lasting and create a better leak tight connection.



**"FI" & "FE" Series
Automated Tube / Thread**



Tech Info Page A4

**FasTest Internal "FI"
Automated Tube / Thread**



Internal "FI" Pages A11 - A15

**FasTest External "FE"
Automated Tube / Thread**



External "FE" Pages A16 - A22

**"ME" & "ML" Medical Series
Automated Tube / Luer**



Pages B1 - B4

**Electronic Tool System - ETS
Automated Tube / Thread**



Pages C1 - C14

**"MIT" & "MET" TwistMate Series
Twist to Connect - Threads**



Pages D1 - D16

**"FN" FasMate Series
for Internal Threads**



Pages E1 - E11

**"JNL" & "JXL" Series, Grip and Seal
Smooth Tube Connectors**



Pages F1 - F6

**"ST" & "XT" Series, Grip and Seal
Smooth and Formed Tubes**



Pages G1 - G3

**"60" Series & "HPB" Series
Sleeve Actuated for Threads**



Pages H1 - H3

**Custom Connector Applications
Fittings, Tubes and More**



"MBE"
Series

"70"
Series

"FIG" Series

Pages J1 - J6

Web Tools Search Tips:
Connectors, Replacement
Seals and Instructions, etc.

Pages B4, D16, F6, G3, K7-K8

Custom App Form Page J6
Index Page K1
ReConnect Page K9
Warranty Page K9

*See section pages for
detailed selection guides

FI - FE

ME - ML

ETS

TwistMate

FasMate

JNL - JXL

ST - XT

60 - HPB

Custom

Index

TwistMate®

FasTest's complete product family of **TwistMate** connectors, plugs and caps provide fast leak tight threaded connections for testing, filling, flushing, plugging, calibrating or venting applications. Simply spin our connectors finger-tight onto thread until face seal contacts test piece.

TwistMates seal automatically when the system is pressurized. Air, gas or hydraulic pressure in the system provides a sealing force that presses the main seal against the face of the threads. This automatic internal piston action maintains the seal with minimum pressure.



TwistMate

Features:

- Pressure assisted grip and seal technology
- Available in NPT, BSPP, BSPT, SAE, Metric and special thread profiles
- Repair kits available for extended connector service life
- Finger-tight pneumatic or hydraulic connections from vacuum to 10,000 psi
- Stainless steel construction for corrosion resistance
- Reduce production losses, retest time, scrap and test damage repair costs

Applications:

- Water dunk leak testing
- Leak, flow, flushing or washing
- Cylinders, manifolds, valves, pumps filters and assemblies
- Bubble, pressure decay and mass spectrometer testing
- Heat exchangers, brake and steering system assemblies
- Capping and plugging pipes, fittings or hose ends

	Contents	Page(s)
	Tech Info	D1-D3
Internal Threads	NPT	D4
	SAE	D6
	BSPP	D7
	BSPT	D8
	Plugs - All	D9
	Metric	D10
External Threads	NPT	D11
	SAE	D13
	BSPP	D14
	BSPT	D14
	Caps - All	D15

The TwistMate Technology

The **TwistMate** family of products use an innovative “*twist to connect*” and pressure assisted grip and seal technology to deliver a fast, safe and repeatable high pressure or vacuum testing connection in threaded ports

or tubing. This sealing technique creates an improved seal as pressures increase and eliminates the traditional sealing methods using tape and wrenches that can damage internal or external threads.

“MIT Series” Connectors for Internal / Female Threads

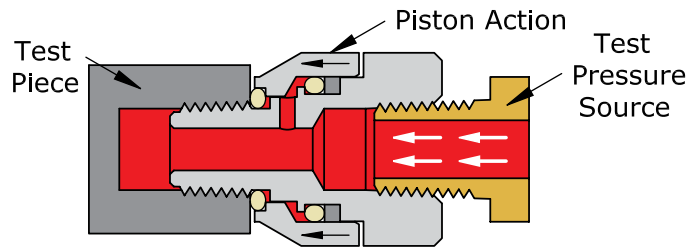
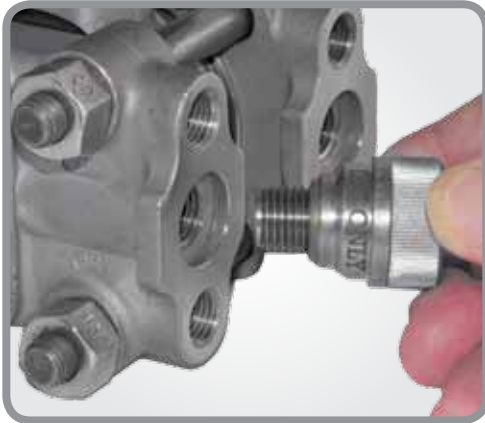

1. Spin **TwistMate** into the threaded port until the seal makes contact.
2. Introduce the media and pressure. The external sleeve automatically moves toward the test piece enhancing the seal squeeze. Vacuum applications will require finger tightening.

“MET Series” Connectors for External / Male Threads

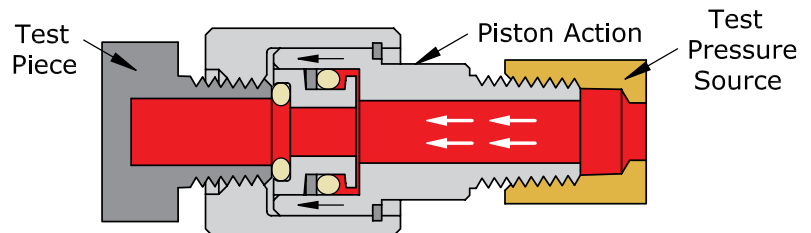

1. Spin **TwistMate** on to the threaded port until the seal makes contact.
2. Introduce the media and pressure. The internal piston automatically moves toward the test piece enhancing the seal squeeze. Vacuum applications will require finger tightening.

TwistMate® - Threaded Connectors

TwistMate Part Number Key

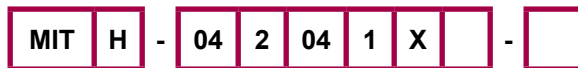

Model

MET - Mechanical External Thread
MIT - Mechanical Internal Thread

Optional Configurations

Blank = Standard
 C = For curved surfaces
 H = High pressure

Connector Size	NPT BSPP/T	SAE	Metric
02	1/8	--	--
03	--	3/8-24	--
04	1/4	7/16-20	--
05	--	1/2-20	--
06	3/8	9/16-18 or 5/8-18	--
08	1/2	3/4-16	--
10	--	7/8-14	M10 x 1
12	3/4	1 1/16-12	M12 x 1
14	--	1 3/16-12	M14 x 1
161	1 5/16-12	M16 x 1
18	--	--	M18 x 1.5
20	1-1/4	1 5/8-12	M20 x 1.5
22	--	--	M22 x 1.5
24	1-1/2	1 7/8-12	--
322	--	--
402-1/2	--	--
483	--	--
644	--	--

Connector Type

- 1 = Female NPT
- 2 = Male NPT
- 3 = Female SAE, O-ring Boss
- 4 = Male SAE O-ring Boss
- 5 = Female BSPP
- 5T = Female BSPT
- 6 = Male BSPP
- 6T = Male BSPT
- 7 = Female metric
- 8 = Male metric
- 9 = Female SAE 37° flare
- 0 = Male SAE 37° flare
- A = Female SAE 45° flare

Special Options

Blank = None
 PT = For thin walled pipe threads

Seal Material

Blank = Standard seal (see individual part numbers)
 B = Buna-N
 E = EPDM
 N = Neoprene
 S = Silicone
 U = Urethane
 V = Viton

Connector Configuration

Blank = Swivel style
 X = Non-Swivel connector

Termination Type

- 1 = Female NPT
- 2 = Male NPT
- 3 = Female SAE, O-ring Boss
- 4 = Male SAE O-ring Boss
- 5 = Female BSPP
- 5T = Female BSPT
- 6 = Male BSPP
- 6T = Male BSPT
- 7 = Female metric
- 8 = Male metric
- 9 = Female SAE 37° flare
- 0 = Male SAE 37° flare
- A = Female SAE 45° flare

Termination Size	NPT	SAE
02	1/8	--
04	1/4	7/16-20
06	3/8	9/16-18
08	1/2	3/4-16
10	--	7/8-14
12	3/4	1 1/16-12
16	1	--
20	1-1/4	--
24	1-1/2	--
C = Cap		
P = Plug		

TwistMate

Notes:

Part Number Keys are to assist in IDENTIFICATION ONLY.
 Verify new part numbers with factory; some configurations are not possible.

TwistMate® - Threaded Connectors

Connectors for Internal (Female) NPT Threads

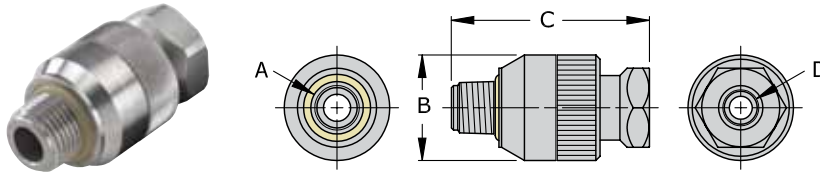

NPT - Swivel Style (per SAE J476 or ANSI B1.20)

Part Number	Dim A	Dim B	Dim C	Dim D	Rating PSI	Housing Style	Seal Material	Repair Kit	Main Seals Package (5)
MIT-022021	1/8" NPT	0.82"	1.68"	1/8" NPT	5000	Swivel	Urethane*	MITR-020	S1109-U70
MIT-042041	1/4" NPT	1.00"	1.88"	1/4" NPT				MITR-040	S1111-U70
MIT-062061	3/8" NPT	1.18"	2.09"	3/8" NPT	4000			MITR-060	S1113-U70
MIT-082081	1/2" NPT	1.36"	2.57"	1/2" NPT				MITR-080	S1209-U70
MIT-122121	3/4" NPT	1.68"	2.73"	3/4" NPT				MITR-12	S1109-U70
MIT-162161	1" NPT	2.00"	3.27"	1" NPT				MITR-16	S1010-U70

*Optional seal materials are FKM (Viton), EPDM and Buna N - Example: MIT-022021E = EPDM

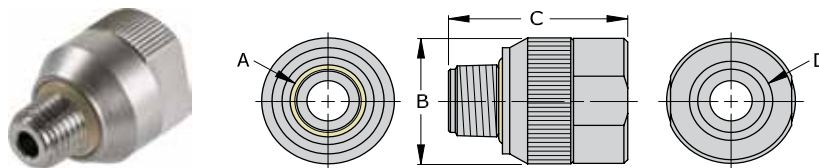

NPT - Non-Swivel Style (per SAE J476 or ANSI B1.20)

Part Number	Dim A	Dim B	Dim C	Dim D	Rating PSI	Housing Style	Seal Material	Repair Kit	Main Seals Package (5)
MIT-022021X	1/8" NPT	0.82"	1.24"	1/8" NPT	5000	Non Swivel	Urethane*	MITR-02	S1109-U70
MIT-042041X	1/4" NPT	1.00"	1.41"	1/4" NPT				MITR-04	S1111-U70
MIT-062061X	3/8" NPT	1.18"	1.48"	3/8" NPT	4000			MITR-06	S1113-U70
MIT-082081X	1/2" NPT	1.36"	1.85"	1/2" NPT				MITR-08	S1209-U70
MIT-122121X	3/4" NPT	1.68"	1.94"	3/4" NPT				MITR-12	S1213-U70
MIT-162161X	1" NPT	2.00"	2.07"	1" NPT				MITR-16	S1216-U70
MIT-202201X	1-1/4" NPT	2.38"	2.13"	1-1/4" NPT	3000			MITR-20	S1222-U70
MIT-242241X	1-1/2" NPT	2.74"	2.40"	1-1/2" NPT				MITR-24	S1327-U70
MIT-322161X	2" NPT	3.47"	2.68"	1" NPT	2500			MITR-32	S1331-U70
MIT-402161X	2-1/2" NPT	3.97"	3.42"	1" NPT				1500	MITR-40
MIT-482161X	3" NPT	4.73"	3.68"	1" NPT	MITR-48				S1340-U70
MIT-642161X	4" NPT	5.73"	3.68"	1" NPT	1000				MITR-64

*Optional seal materials are FKM (Viton), EPDM and Buna N - Example: MIT-022021XY = FKM (Viton)

TwistMate® - Threaded Connectors

Connectors for Internal (Female) NPT Threads on Curved Surfaces

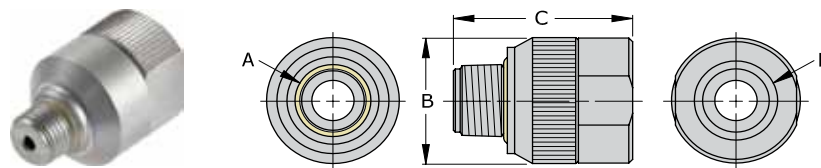

NPT - Non-Swivel Style for Curved Surfaces (per SAE J476 or ANSI B1.20)

Part Number	Dim A	Dim B	Dim C	Dim D	Rating PSI	Housing Style	Seal Material	Repair Kit	Main Seals Package (5)
MITC-022021X	1/8" NPT	0.82"	1.24"	1/8" NPT	5000	Non Swivel	Urethane*	MITR-02	S1010-U70
MITC-042041X	1/4" NPT	1.00"	1.41"	1/4" NPT				MITR-04	S1013-U70

*Optional seal materials are FKM (Viton), EPDM and Buna N - Example: MITC-042041XB = Buna N

The **TwistMate** MITC Series connectors are designed to seal the port on the round of a surface better and with less effort. The unique chamfer seal design provides positive sealing with no thread sealants or wrench tightening.

Part Number	Max. at Dim A	Bore Ø. Dim B	Chamfer Ø Dim C	Min. Body Ø Dim D
MITC-022021X	0.030"	0.500"	1.24"	0.880"
MITC-042041X	0.045"	0.625"	1.41"	1.200"

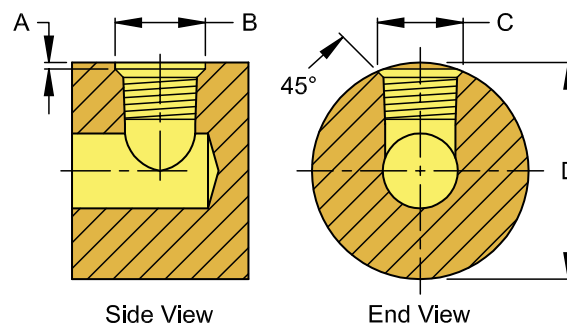

TwistMate

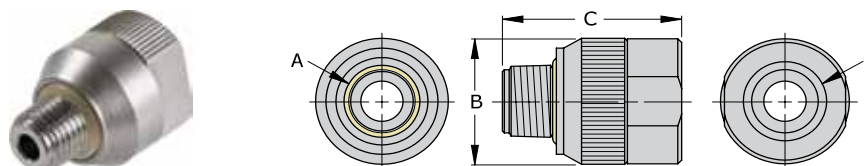

NPT - Non-Swivel Style for High Pressure (per SAE J476 or ANSI B1.20)

Part Number	Dim A	Dim B	Dim C	Dim D	Rating PSI	Housing Style	Seal Material	Repair Kit	Main Seals Package (5)
MITH-022021X	1/8" NPT	0.82"	1.24"	1/8" NPT	10,000	Non Swivel	Urethane*	MITR-02	S1109-U70
MITH-042041X	1/4" NPT	1.00"	1.41"	1/4" NPT				MITR-04	S1111-U70
MITH-062061X	3/8" NPT	1.18"	1.48"	3/8" NPT				MITR-06	S1113-U70
MITH-082081X	1/2" NPT	1.36"	1.85"	1/2" NPT	8000			MITR-08	S1209-U70
MITH-122121X	3/4" NPT	1.68"	1.94"	3/4" NPT	7500			MITR-12	S1213-U70
MITH-162161X	1" NPT	2.00"	2.07"	1" NPT	6500			MITR-16	S1216-U70

*Optional seal materials is EPDM - Example: MITH-042041XE = EPDM

TwistMate® - Threaded Connectors

Connectors for Internal (Female) SAE O-Ring Boss Threads

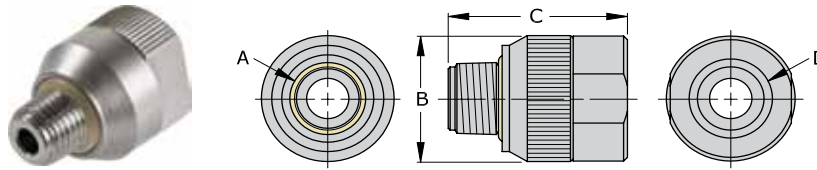

SAE - Non-Swivel Style (per SAE J1926 or ISO 11926)

Part Number	Dim A	Dim B	Dim C	Dim D	Rating PSI	Housing Style	Seal Material	Repair Kit	Main Seals Package (5)		
MIT-034021X	-3 (3/8-24)	0.82"	1.29"	1/8" NPT	5000	Non Swivel	Urethane*	MITR-02	S1109-U70		
MIT-044021X	-4 (7/16-20)	0.82"	1.29"	1/8" NPT					S1109-U70		
MIT-054041X	-5 (1/2-20)	1.00"	1.41"	1/4" NPT				MITR-04	S1111-U70		
MIT-064041X	-6 (9/16-18)	1.00"	1.41"	1/4" NPT					S1111-U70		
MIT-084081X	-8 (3/4-16)	1.36"	1.85"	1/2" NPT	4000			Non Swivel	Urethane*	MITR-08	S1209-U70
MIT-104081X	-10 (7/8-14)	1.36"	1.85"	1/2" NPT							S1209-U70
MIT-124121X	-12 (1 1/16-12)	1.68"	1.94"	3/4" NPT						MITR-12	S1213-U70
MIT-144161X	-14 (1 3/16-12)	2.00"	2.13"	1" NPT							S1216-U70
MIT-164161X	-16 (1 5/16-12)	2.00"	2.13"	1" NPT		MITR-16	S1217-U70				
MIT-204201X	-20 (1 5/8-12)	2.38"	2.13"	1-1/4" NPT			S1222-U70				

*Optional seal materials are FKM (Viton), EPDM and Buna N - Example: MIT-044021XV = FKM (Viton)

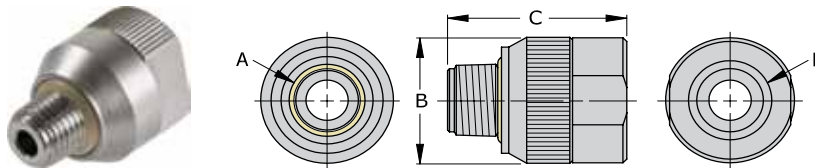

SAE - Non-Swivel Style for High Pressure (per SAE J1926 or ISO 11926)

Part Number	Dim A	Dim B	Dim C	Dim D	Rating PSI	Housing Style	Seal Material	Repair Kit	Main Seals Package (5)
MITH-044021X	-4 (7/16-20)	0.82"	1.29"	1/8" NPT	10,000	Non Swivel	Urethane*	MITR-02	S1109-U70
MITH-064041X	-6 (9/16-18)	1.00"	1.41"	1/4" NPT					S1111-U70
MITH-084081X	-8 (3/4-16)	1.36"	1.85"	1/2" NPT	8000			MITR-08	S1209-U70
MITH-104081X	-10 (7/8-14)	1.36"	1.85"	1/2" NPT					S1209-U70
MITH-124121X	-12 (1 1/16-12)	1.68"	1.94"	3/4" NPT	7500			MITR-12	S1213-U70
MITH-144161X	-14 (1 3/16-12)	2.00"	2.13"	1" NPT					S1216-U70
MITH-164161X	-16 (1 5/16-12)	2.00"	2.13"	1" NPT	7000			MITR-16	S1217-U70

*Optional seal materials is EPDM - Example: MITH-064041XE = EPDM

TwistMate® - Threaded Connectors

Connectors for Internal (Female) BSPG Threads

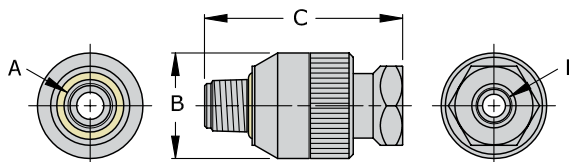

BSPG - Swivel Style (per ISO 228 or BS 2779)

Part Number	Dim A	Dim B	Dim C	Dim D	Rating PSI	Housing Style	Seal Material	Repair Kit	Main Seals Package (5)
MIT-026021	1/8" BSPG	0.82"	1.24"	1/8" NPT	5000	Swivel	Urethane*	MITR-020	S1109-U70
MIT-046041	1/4" BSPG	1.00"	1.41"	1/4" NPT				MITR-040	S1111-U70
MIT-066061	3/8" BSPG	1.18"	1.48"	3/8" NPT	4000			MITR-060	S1113-U70
MIT-086081	1/2" BSPG	1.36"	1.85"	1/2" NPT				MITR-080	S1209-U70

*Optional seal materials are FKM (Viton), EPDM and Buna N - Example: MIT-046041XB = Buna N

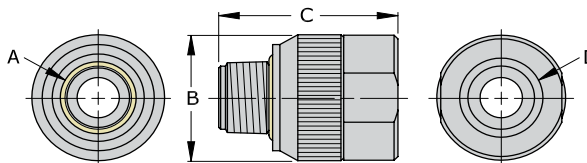

BSPG - Non-Swivel Style (per ISO 228 or BS 2779)

Part Number	Dim A	Dim B	Dim C	Dim D	Rating PSI	Housing Style	Seal Material	Repair Kit	Main Seals Package (5)
MIT-126121X	3/4" BSPG	1.68"	1.94"	3/4" NPT	4000	Non Swivel	Urethane*	MITR-12	S1213-U70
MIT-166161X	1" BSPG	2.00"	2.07"	1" NPT		MITR-16		S1216-U70	

*Optional seal materials are FKM (Viton), EPDM and Buna N - Example: MIT-126121XV = FKM (Viton)

TwistMate

TwistMate® - Threaded Connectors

Connectors for Internal (Female) BSPT Threads

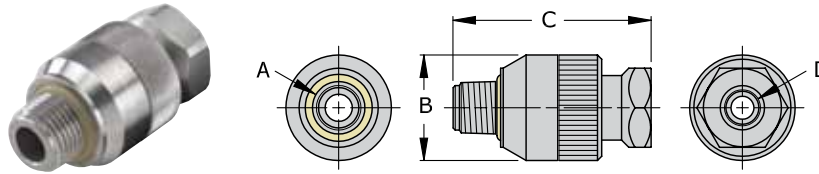

BSPT - Swivel Style (per ISO 7 or BS 21)

Part Number	Dim A	Dim B	Dim C	Dim D	Rating PSI	Housing Style	Seal Material	Repair Kit	Main Seals Package (5)
MIT-026T021	1/8" BSPT	0.82"	1.24"	1/8" NPT	5000	Swivel	Urethane*	MITR-020	S1109-U70
MIT-046T041	1/4" BSPT	1.00"	1.41"	1/4" NPT				MITR-040	S1111-U70
MIT-066T061	3/8" BSPT	1.18"	1.48"	3/8" NPT	4000			MITR-060	S1113-U70
MIT-086T081	1/2" BSPT	1.36"	1.85"	1/2" NPT				MITR-080	S1209-U70

*Optional seal materials are FKM (Viton), EPDM and Buna N - Example: MIT-046T041XV = FKM (Viton)

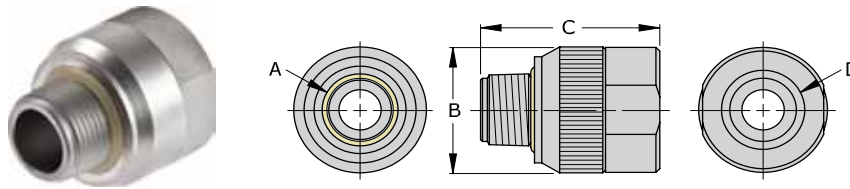

BSPT - Non-Swivel Style (per ISO 7 or BS 21)

Part Number	Dim A	Dim B	Dim C	Dim D	Rating PSI	Housing Style	Seal Material	Repair Kit	Main Seals Package (5)
MIT-126T121X	3/4" BSPT	1.68"	1.94"	3/4" NPT	4000	Non Swivel	Urethane*	MITR-12	S1213-U70
MIT-166T161X	1" BSPT	2.00"	2.07"	1" NPT				MITR-16	S1216-U70

*Optional seal materials are FKM (Viton), EPDM and Buna N - Example: MIT-126T121E = EPDM

TwistMate® - Threaded Connectors

Plugs for Internal (Female) NPT, BSPP and BSPT Threads

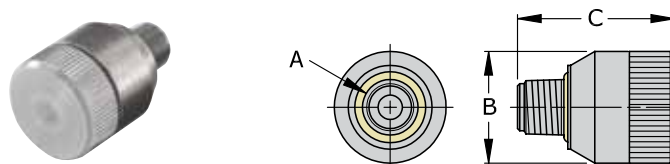

NPT Threads (per SAE J476 or ANSI B1.20)

Part Number	Dim A	Dim B	Dim C	Rating PSI	Housing Style	Seal Material	Repair Kit	Main Seals Package (5)
MIT-022P	1/8" NPT	0.82"	1.24"	5000	Plug	Urethane*	MITR-02	S1109-U70
MIT-042P	1/4" NPT	1.00"	1.41"				MITR-04	S1111-U70
MIT-062P	3/8" NPT	1.18"	1.48"	4000			MITR-06	S1113-U70
MIT-082P	1/2" NPT	1.36"	1.85"				MITR-08	S1209-U70
MIT-122P	3/4" NPT	1.68"	1.94"				Consult Factory	S1213-U70
MIT-162P	1" NPT	2.00"	2.07"					S1216-U70

*Optional seal materials are FKM (Viton), EPDM and Buna N - Example: MIT-042PV = FKM (Viton)

BSPP Threads (per ISO 228 or BS 2779)

Part Number	Dim A	Dim B	Dim C	Rating PSI	Housing Style	Seal Material	Repair Kit	Main Seals Package (5)
MIT-026P	1/8" BSPP	0.82"	1.24"	5000	Plug	Urethane*	MITR-02	S1109-U70
MIT-046P	1/4" BSPP	1.00"	1.41"				MITR-04	S1111-U70
MIT-066P	3/8" BSPP	1.18"	1.48"	4000			MITR-06	S1113-U70
MIT-086P	1/2" BSPP	1.36"	1.85"				MITR-08	S1209-U70

*Optional seal materials are FKM (Viton), EPDM and Buna N - Example: MIT-046PE = EPDM

BSPT Threads (per ISO 7 or BS 21)

Part Number	Dim A	Dim B	Dim C	Rating PSI	Housing Style	Seal Material	Repair Kit	Main Seals Package (5)
MIT-026TP	1/8" BSPT	0.82"	1.24"	5000	Plug	Urethane*	MITR-02	S1109-U70
MIT-046TP	1/4" BSPT	1.00"	1.41"				MITR-04	S1111-U70
MIT-066TP	3/8" BSPT	1.18"	1.48"	4000			MITR-06	S1113-U70
MIT-086TP	1/2" BSPT	1.36"	1.85"				MITR-08	S1209-U70

*Optional seal materials are FKM (Viton), EPDM and Buna N - Example: MIT-046PB = Buna N

TwistMate Internal Repair Kits

Swivel style repair kits contains 2 internal Buna N O-rings, 2 backup rings and 1 snap ring.

Non-Swivel style repair kits contain 1 internal Buna N O-ring and 1 backup ring.

Repair kits do not include main seal replacement.

For additional kits consult factory.

TwistMate® - Threaded Connectors

Connectors for Internal (Female) ISO O-Ring Metric Threads

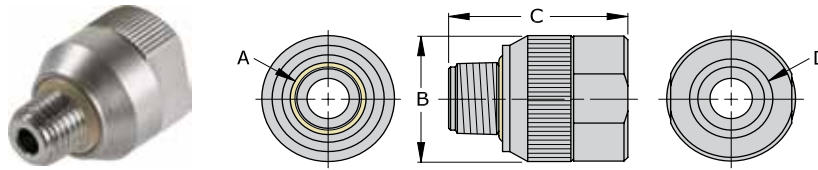

ISO O-Ring Metric - Non-Swivel Style (per ISO 6149 or SAE J2244)

Part Number	Dim A	Dim B	Dim C	Dim D	Rating PSI	Housing Style	Seal Material	Repair Kit	Main Seals Package (5)
MIT-108021X	M10 x 1.0	0.82"	1.30"	1/8" NPT	5000	Non Swivel	Urethane*	MITR-02	S1109-U70
MIT-128041X	M12 x 1.5	1.00"	1.42"	1/4" NPT				MITR-04	S1110-U70
MIT-148041X	M14 x 1.5	1.00"	1.42"	1/4" NPT				MITR-04	S1111-U70
MIT-168061X	M16 x 1.5	1.18"	1.56"	3/8" NPT	4000			MITR-06	S1113-U70
MIT-188061X	M18 x 1.5	1.18"	1.56"	3/8" NPT				MITR-06	S1114-U70
MIT-228081X	M22 x 1.5	1.36"	1.87"	1/2" NPT				MITR-08	S1116-U70

*Optional seal materials are FKM (Viton), EPDM and Buna N - Example: MIT-148041XY = FKM (Viton)

TwistMate® - Threaded Connectors

Connectors for External (Male) NPT Threads

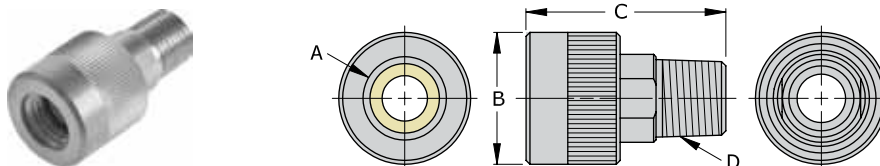

NPT Threads (per SAE J476 or ANSI B1.20)

Part Number	Dim A	Dim B	Dim C	Dim D	Rating PSI	Housing Style	Seal Material	Repair Kit	Main Seals Package (5)
MET-021022	1/8" NPT	0.82"	1.51"	1/8" NPT	5000	Swivel	Urethane*	METR-02	S1105-U70
MET-041042	1/4" NPT	0.94"	1.74"	1/4" NPT				METR-04	S1108-U70
MET-061062	3/8" NPT	1.18"	1.78"	3/8" NPT	METR-06			S1110-U70	
MET-081082	1/2" NPT	1.60"	2.05"	1/2" NPT	METR-08			S1112-U70	
MET-121122	3/4" NPT	1.68"	2.34"	3/4" NPT	METR-12			S1115-U70	
MET-161162	1" NPT	2.00"	2.74"	1" NPT	METR-16			S1212-U70	
MET-201202	1-1/4" NPT	2.37"	3.27"	1-1/4" NPT	2500			METR-20	S1217-U70

TwistMate

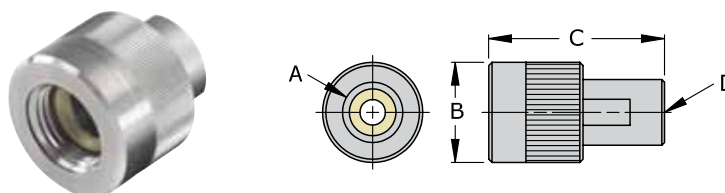

NPT Threads (per SAE J476 or ANSI B1.20)

Part Number	Dim A	Dim B	Dim C	Dim D	Rating PSI	Housing Style	Seal Material	Repair Kit	Main Seals Package (5)
MET-241161	1-1/2" NPT	2.37"	3.27"	1" NPT	1000	Swivel	Urethane*	METR-24	METB24
MET-321161	2" NPT	3.00"	2.53"	1" NPT	750			METR-32	METB32
MET-401161	2-1/2" NPT	3.40"	2.54"	1" NPT	500			METR-40	METB40
MET-481161	3" NPT	4.25"	2.61"	1" NPT				METR-48	METB48

*Optional seal materials are FKM (Viton), EPDM and Buna N - Example: MET-041042E = EPDM

TwistMate® - Threaded Connectors

Connectors for External (Male) NPT Threads

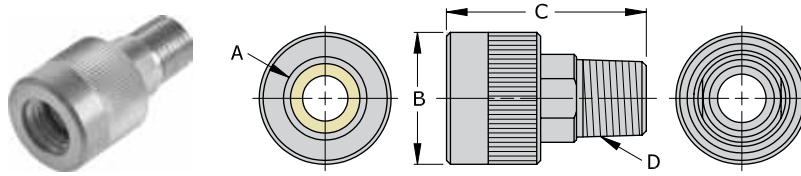

NPT Threads for High Pressure (per SAE J476 or ANSI B1.20)

Part Number	Dim A	Dim B	Dim C	Dim D	Rating PSI	Housing Style	Seal Material	Repair Kit	Main Seals Package (5)
METH-021022	1/8" NPT	0.82"	1.51"	1/8" NPT	10,000	Swivel	Urethane*	METR-02	S1105-U70
METH-041042	1/4" NPT	0.94"	1.74"	1/4" NPT	8000			METR-04	S1108-U70
METH-061062	3/8" NPT	1.18"	1.78"	3/8" NPT	6000			METR-06	S1110-U70
METH-081082	1/2" NPT	1.60"	2.05"	1/2" NPT	5500			METR-08	S1112-U70
METH-121122	3/4" NPT	1.68"	2.34"	3/4" NPT	5000			METR-12	S1115-U70
METH-161162	1" NPT	2.00"	2.74"	1" NPT				METR-16	S1212-U70

*Optional seal materials is EPDM - Example: METH-041042E = EPDM

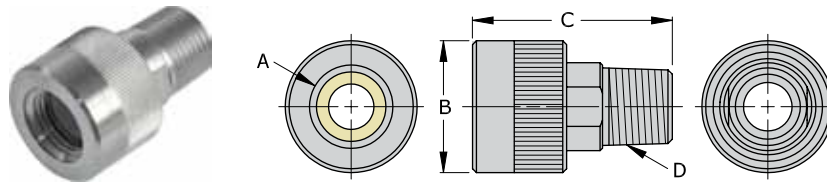

NPT Threads on Thin Walled Threaded Pipe (per SAE J476 or ANSI B1.20)

Part Number	Dim A	Dim B	Dim C	Dim D	Rating PSI	Housing Style	Seal Material	Repair Kit	Main Seals Package (5)
MET-041042-PT	1/4" NPT	0.94"	1.74"	1/4" NPT	750	Swivel	Buna N	METR-04	METB-04PT
MET-061062-PT	3/8" NPT	1.18"	1.78"	3/8" NPT				METR-06	METB-06PT
MET-081082-PT	1/2" NPT	1.60"	2.05"	1/2" NPT				METR-08	METB-08PT
MET-121122-PT	3/4" NPT	1.68"	2.34"	3/4" NPT				METR-12	METB-12PT
MET-161162-PT	1" NPT	2.00"	2.74"	1" NPT				METR-16	METB-16PT
MET-201202-PT	1-1/4" NPT	2.37"	3.27"	1-1/4" NPT				METR-20	METB-20PT
MET-241161*	1-1/2" NPT	2.37"	3.27"	1" NPT	500	Swivel	Urethane	METR-24	METB24
MET-321161	2" NPT	3.00"	2.53"	1" NPT				METR-32	METB32
MET-401161	2-1/2" NPT	3.40"	2.54"	1" NPT				METR-40	METB40
MET-481161	3" NPT	4.25"	2.61"	1" NPT				METR-48	METB48

*Connector pressure rating reduced to 750 psi for thin wall threaded pipe applications.

TwistMate® - Threaded Connectors

Connectors for External (Male) SAE Flare Threads

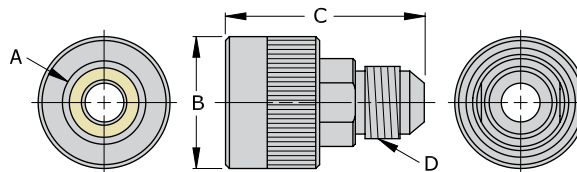

SAE - 37° Flare, "AN" Standard, Swivel Style for High Pressure (per SAE J514 or ISO 12151-5)

Part Number	Dim A	Dim B	Dim C	Dim D	Rating PSI	Housing Style	Seal Material	Repair Kit	Main Seals Package (5)
METH-049040	-4 (7/16-20)	0.95"	1.76"	-4 (7/16-20)	10,000	Swivel	Buna N*	METR-049	S2070-0270B70
METH-069060	-6 (9/16-18)	1.20"	1.83"	-6 (9/16-18)				METR-06	S1012-B70
METH-089080	-8 (3/4-16)	1.38"	2.00"	-8 (3/4-16)				METR-08	S1015-B70
METH-109100	-10 (7/8-14)	1.51"	2.35"	-10 (7/8-14)				METR-08	S1016-B70
METH-129120	-12 (1 1/16-12)	1.70"	2.52"	-12 (1 1/16-12)				METR-12	S1018-B70

*Optional seal materials is EPDM - Example: METH-069060E = EPDM

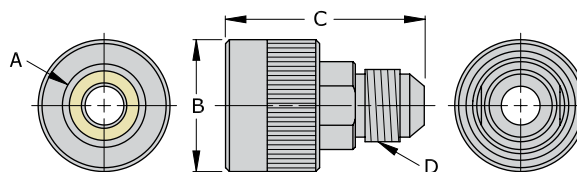

For SAE 45° Flare (per SAE J512 or J513)

Part Number	Dim A	Dim B	Dim C	Dim D	Rating PSI	Housing Style	Seal Material	Repair Kit	Main Seals Package (5)
MET-04A042B	-4 (7/16-20)	0.95"	1.76"	1/4" NPT	5000	Swivel	Buna N**	METR-049	S2060-0246B70
MET-06A062N	-6 (5/8-18)	1.20"	1.83"	3/8" NPT			METR-06	S1012-N70	
MET-08A082N	-8 (3/4-16)	1.38"	2.00"	1/2" NPT	4000		Neoprene*	METR-08	S1014-N70
MET-10A082N	-10 (7/8-14)	1.51"	2.35"	1/2" NPT				METR-08	S1015-N70
MET-12A122N	-12 (1 1/16-14)	1.70"	2.52"	3/4" NPT				METR-12	S1117-N70

*Optional seal materials are FKM (Viton), EPDM and Buna N - Example: MET-08A082NE = EPDM

**Optional seal materials are FKM (Viton) and EPDM - Example: MET-04A042BY = FKM (Viton)

TwistMate® - Threaded Connectors

Connectors for External (Male) BSPB and BSPT Threads

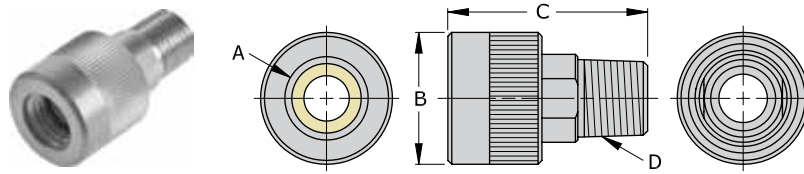

BSPP - Swivel Style (per ISO 228 or BS 2779)

Part Number	Dim A	Dim B	Dim C	Dim D	Rating PSI	Housing Style	Seal Material	Repair Kit	Main Seals Package (5)
MET-025022	1/8" BSPP	0.80"	1.62"	1/8" NPT	5000	Swivel	Urethane*	METR-02	S1105-U70
MET-045042	1/4" BSPP	0.93"	1.63"	1/4" NPT				METR-04	S1108-U70
MET-065062	3/8" BSPP	1.20"	1.31"	3/8" NPT	4000			METR-06	S1110-U70
MET-085082	1/2" BSPP	1.36"	1.46"	1/2" NPT				METR-08	S1112-U70

*Optional seal materials are FKM (Viton), EPDM and Buna N - Example: MET-045042**E** = Buna N

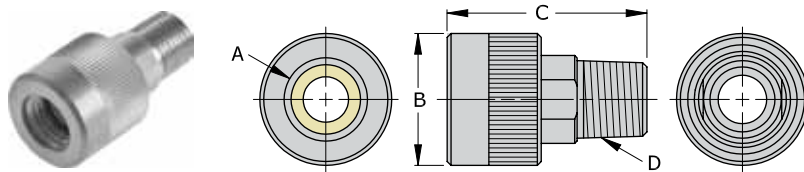

BSPT - Swivel Style (per ISO 7 or BS 21)

Part Number	Dim A	Dim B	Dim C	Dim D	Rating PSI	Housing Style	Seal Material	Repair Kit	Main Seals Package (5)
MET-025T022	1/8" BSPT	0.80"	1.62"	1/8" NPT	5000	Swivel	Urethane*	METR-02	S1105-U70
MET-045T042	1/4" BSPT	0.93"	1.63"	1/4" NPT				METR-04	S1108-U70
MET-065T062	3/8" BSPT	1.20"	1.31"	3/8" NPT	4000			METR-06	S1110-U70
MET-085T082	1/2" BSPT	1.36"	1.46"	1/2" NPT				METR-08	S1112-U70

*Optional seal materials are FKM (Viton), EPDM and Buna N - Example: MET-045T042**E** = EPDM

TwistMate® - Threaded Connectors

Caps for External (Male) NPT, BSPP and BSPT Threads

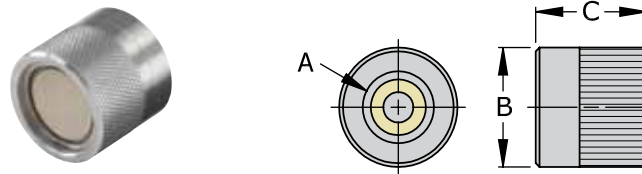

Cap Style for NPT Threads (per SAE J476 or ANSI B1.20)

Part Number	Dim A	Dim B	Dim C	Rating PSI	Housing Style	Seal Material	Repair Kit	Main Seals Package (5)
MET-021C	1/8" NPT	0.80"	0.83"	5000	Cap	Urethane*	METR-02	S1105-U70
MET-041C	1/4" NPT	0.93"	0.88"				METR-04	S1108-U70
MET-061C	3/8" NPT	1.20"	0.90"	4000			METR-06	S1110-U70
MET-081C	1/2" NPT	1.36"	0.97"				METR-08	S1112-U70

*Optional seal materials are FKM (Viton), EPDM and Buna N - Example: MET-041CV = FKM (Viton)

Cap Style for BSPP Threads (per ISO 228 or BS 2779)

Part Number	Dim A	Dim B	Dim C	Rating PSI	Housing Style	Seal Material	Repair Kit	Main Seals Package (5)
MET-025C	1/8" BSPP	0.80"	0.83"	5000	Cap	Urethane*	METR-02	S1105-U70
MET-045C	1/4" BSPP	0.93"	0.88"				METR-04	S1108-U70
MET-065C	3/8" BSPP	1.20"	0.90"	4000			METR-06	S1110-U70
MET-085C	1/2" BSPP	1.36"	0.97"				METR-08	S1112-U70

*Optional seal materials are FKM (Viton), EPDM and Buna N - Example: MET-045CE = EPDM

Cap Style for BSPT Threads (per ISO 7 or BS 21)

Part Number	Dim A	Dim B	Dim C	Rating PSI	Housing Style	Seal Material	Repair Kit	Main Seals Package (5)
MET-025TC	1/8" BSPT	0.80"	0.83"	5000	Cap	Urethane*	METR-02	S1105-U70
MET-045TC	1/4" BSPT	0.93"	0.88"				METR-04	S1108-U70
MET-065TC	3/8" BSPT	1.20"	0.90"	4000			METR-06	S1110-U70
MET-085TC	1/2" BSPT	1.36"	0.97"				METR-08	S1112-U70

*Optional seal materials are FKM (Viton), EPDM and Buna N - Example: MET-045TCB = Buna N

TwistMate Internal Repair Kits

Swivel style repair kits contains 2 internal Buna N O-rings, 2 backup rings and 1 snap ring.

Non-Swivel style repair kits contain 1 internal Buna N O-ring and 1 backup ring.

Repair kits do not include main seal replacement.

For additional kits consult factory.

Need assistance finding a TwistMate connector for your application?

- Visit www.fastestinc.com and select “Connection Type” under “Products”
- Select a basic feature of your application such as “External Threads”
- Select **TwistMate** under Product Family or applications features such as “Connects to” to shorten your results list

Your Selections **Connection Type: External Threads** **Product Family: TwistMate**

Application
 Calibration (49)
 Manufacturing (53)

Connection Type
 External Threads (59)

Connects To
 -10 (7/8-14) (2)
 -12 (1 1/16-12) (1)
 -12 (1 1/16-14) (1)
 -4 (7/16-20) (3)
 -6 (5/8-16) (1)
 -6 (9/16-18) (2)
 -8 (3/4-16) (3)

MET-021021
 Twist to connect for instant connection to 1/8" NPT male threads, swivel style, Urethane seals

Product Family	Connection Type	Connection Method
TwistMate	External Threads	Twist to Connect
Connects To	Pressure Rating	Termination
1/8" NPT	5000	1/8" NPT (Female)

On-line Price: Request a Quote [LEARN MORE](#) [ADD TO QUOTE](#)

Need operating or seal replacement instructions to extend connector service life?

- Find your connector above or use the part number search field in the website header, click “Learn More” button
- Select the “Instructions” tab to display links to current instruction documents

MET-021021
 Twist to connect for instant connection to 1/8" NPT male threads, swivel style, Urethane seals

Product Family	Connection Type	Connection Method
TwistMate	External Threads	Twist to Connect
Connects To	Pressure Rating	Termination
1/8" NPT	5000	1/8" NPT (Female)

[FIND A DEALER](#) [ADD TO QUOTE](#)

Overview Specifications **Instructions** CAD Models Related Products

Click on the document below to view or download the appropriate operating and maintenance instructions for the **TwistMate** Series connectors from **FasTest** for external threads. Proper use of the connectors will ensure safe operation and maximum connector life.

- [TwistMate Series - Operating Instructions \(MET\)](#)
- [TwistMate Series - Seal Replacement Instructions \(MET\)](#)

Connector Refurbishment Program

ReConnect



Extend the service life and warranty of your investment - Our connector refurbishment and competitor replacement program delivers the latest product improvements and ensures proper connector operation and performance in your application. Connectors routinely maintained can be refurbished or replaced economically relative to the cost of a new connector replacement.

Visit www.fastestinc.com or contact **FasTest** for details.

Warranty

Limited Express Warranty

FasTest Inc. warrants its products against defects in workmanship and materials for 12 months from the date of sale by FasTest Inc. or its authorized distributors. This warranty is void if the product is misused, tampered with or used in a manner that is contrary to FasTest Inc.'s written recommendations and/or instructions.

FasTest Inc. does not warrant the suitability of the product for any particular application. Determining product application suitability is solely the customer's responsibility. FasTest Inc. is not liable for consequential or other damages including, but not limited to, loss, damage, personal injury, or any other expense directly or indirectly arising from the use of or inability to use its products either separately or in combination with other products.

ALL OTHER WARRANTIES EXPRESS OR IMPLIED, WHETHER ORAL, WRITTEN OR IN ANY OTHER FORM, INCLUDING BUT NOT LIMITED TO WARRANTIES OF MERCHANTABILITY OR FITNESS FOR A PARTICULAR PURPOSE ARE EXPRESSLY EXCLUDED.

The sole and exclusive remedy under this warranty is limited to replacement of the product or an account credit in the amount of the original selling price, at the option of FasTest Inc. All allegedly defective products must be returned prepaid transportation to FasTest Inc., together with information describing the product's performance, unless disposition in the field is authorized in writing by FasTest Inc.

Notifications and Copyright

Notifications and Copyright

Specifications in this brochure are subject to change without notice. FasTest also reserves the right to make modifications and makes no guarantee of the accuracy of the information contained herein.

© 2012 FasTest Inc. All rights reserved. No part of this publication may be reproduced without written permission.



Calibration Connectors

The **FasCal** complete line of plug and play connectors for lab and field instrument calibration without the use of tapes, sealants and wrenches.



Medical Connectors

Versatile product line of connectors and systems for sealing and testing a wide variety of medical products and drug delivery devices.



Refrigeration Connections

The **CoreMax** system of high flow processing valves and connectors for the refrigeration manufacturing and service industry.

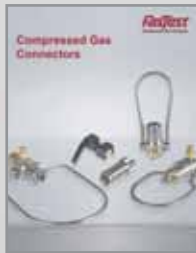

Compressed Gas Connectors

Innovative gas connectors for common CGA standards used in conventional and residual pressure valve filling applications.

FasTest[®]

1646 Terrace Drive • Roseville, MN 55113-1317

Phone: 651.645.6266 • Fax: 651.645.7390

Toll-free: 1.800.444.2373

www.fastestinc.com

MKMF100 4/12

美国FasTest中国区代理商：

深圳市慧烁机电有限公司

深圳市南山大道2019号

福临苑大厦16E (518052)

电话：0755-8621 5125 / 5145

传真：0755-8621 5195

邮箱：info@wisbay.cn

网站：www.wisbay.cn

上海办事处

上海市浦东新区新金桥路1088号

联创国际大厦1514室(201206)

电话：021-6100 5201 / 5202

传真：021-6100 5195

© 2012 FasTest Inc. All rights reserved.